

Installation instruction

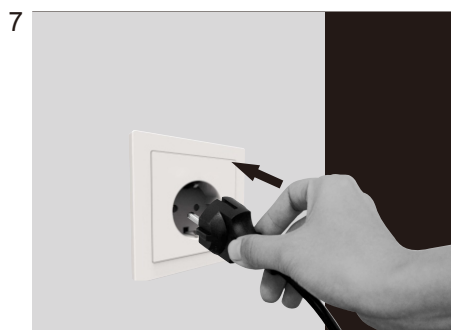

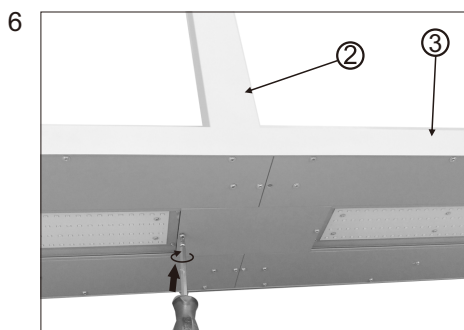

A. Motion Sensor

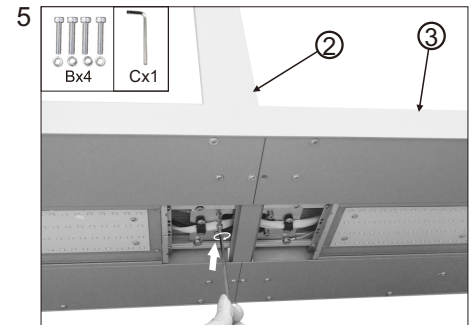
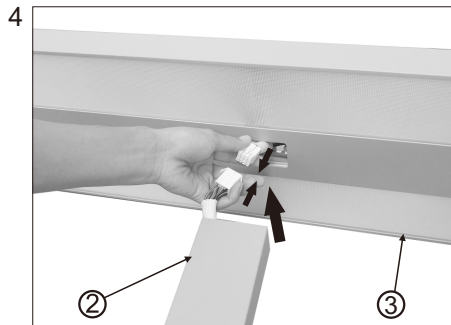
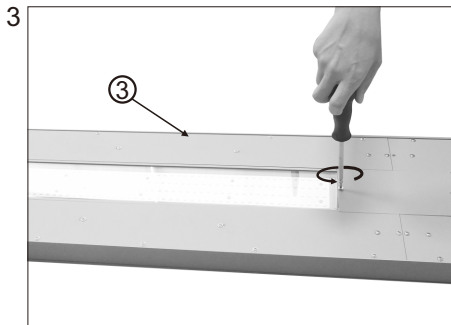
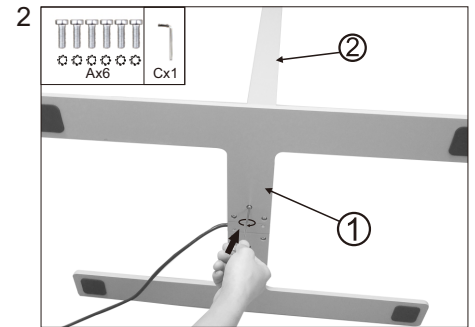
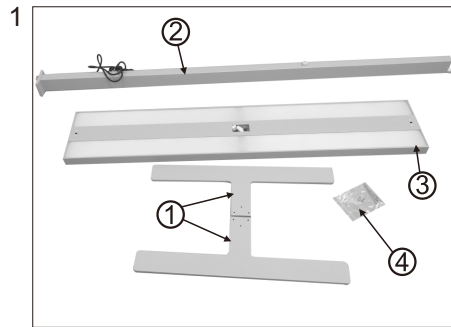
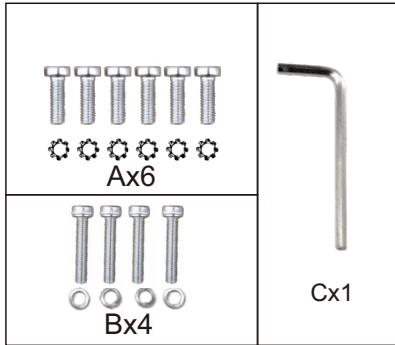
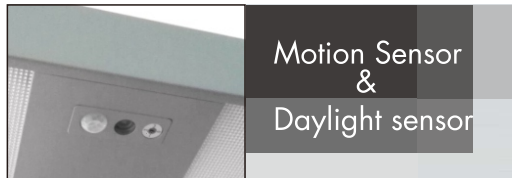
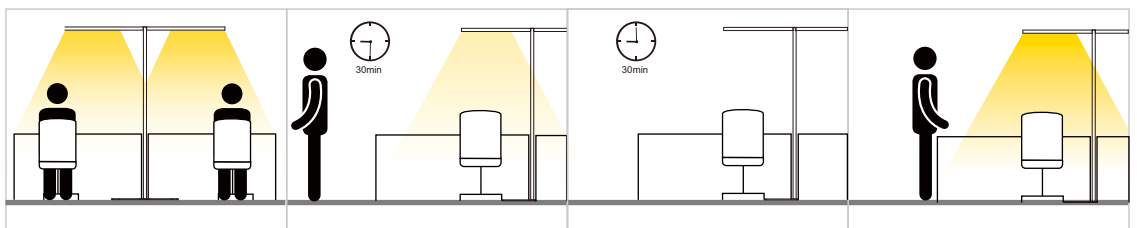

2. The lamp brightness reduce to 30% when there is no presence in 30min

3. After another 30min, the lamp switches off automatically when still no presence detected

4. The lamp will switches on automatically at once when there is presence detected.

B. Daylight Sensor

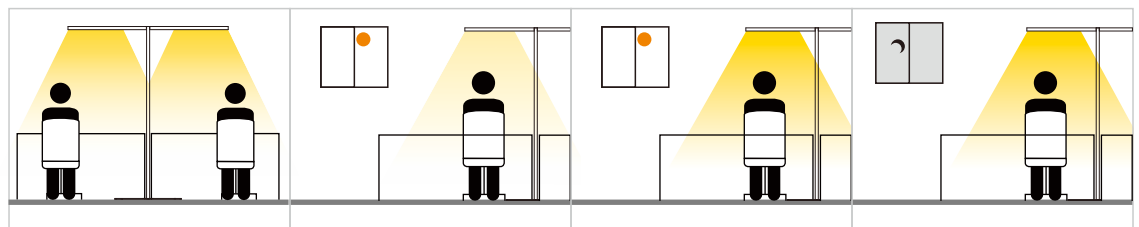

After each time manually adjust the brightness, the control unit record the brightness which sensor detected and save this memory until the next time brightness dimming. (**Note: please be sure to adjust and dim the lamp at a comfortable and soft light state**)

The control unit can dims light output down or up automatically according to the changes of environment brightness to have a relatively constant light level for a desk in office situation.

Detectable area

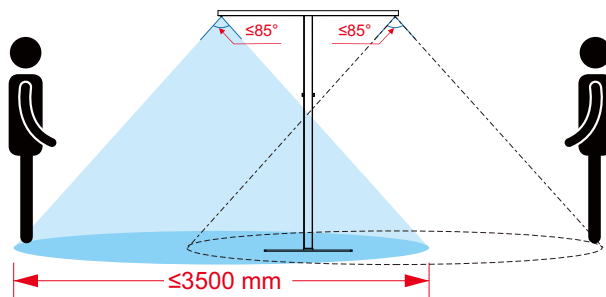

Here to tell you how to play **Motion Sensor & Daylight Sensor**

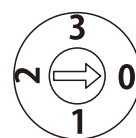
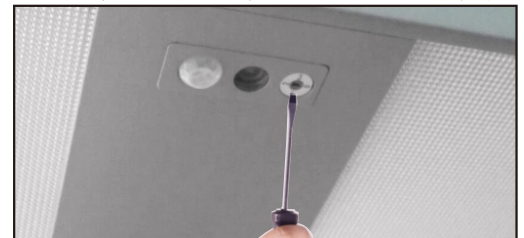

Dip switches	information	Motion sensor	Daylight sensor
0		OFF	OFF
1		ON	OFF
2		ON	ON
3		OFF	ON

Adjust the dip switch to the module by screwdriver.